

Deep groove ball bearings - Single-row - Shielded/sealed type - Contact sealed

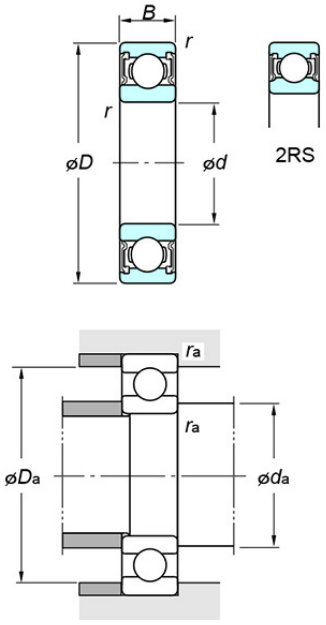

Bearing No. 6000 2RS

Specifications

(Boundary dimensions ...etc)

d(mm)	10
D(mm)	26
B(mm)	8
r(min.)(mm)	0.3
Basic load ratings : Cr(kN)	5.70
Basic load ratings : C0r(kN)	1.95
Fatigue load limit : Cu(kN)	0.100
factor : f0(l)	12.3
Limiting speeds(Grease lub.)(min-1)	19000
Limiting speeds(Oil lub.)(min-1)	

Mounting dimensions

da(min.)(mm)	12
da(max.)(mm)	13
Da(max.)(mm)	24
ra(max.)(mm)	0.3

Refer.

(Refer.)Mass(kg)	0.019
------------------	-------